

Read / Write amplifier for FDD

BH6627FS

The BH6627FS is a 4-mode read / write IC designed for floppy disk drives. This IC has an internal active filter that can be set to any of multiple settings according to transfer rate, and internal switches for density and inner track/outer track. Write current can be set to any of multiple settings.

●Applications

Floppy disk drives (1MB, 1.6MB and 2MB drives)

●Features

- 1) Internal active filter with four settings that can be selected for multiple Q and f_0 .
- 2) Time domain filter with internal switch set according to transfer rate.
- 3) Any of multiple write current settings can be selected, and inner track/outer track switching is done internally.

●Absolute maximum ratings (Ta = 25°C)

Parameter	Symbol	Limits	Unit
Power supply voltage	V _{cc}	+7	V
Operating temperature	T _{opr}	0~+70	°C
Storage temperature	T _{stg}	-55~+125	°C
Digital input voltage	V _I	-0.5~V _{cc} +0.3	V
RW pin voltage	VRW	+15	V
LVS output voltage	VLVS	V _{cc} +0.3	V
ED pin voltage	VER	V _{cc} +0.3	V
Power dissipation	P _d	650*	mW

* Reduced by 6.5mW for each increase in Ta of 1°C over 25°C.

●Recommended operating conditions

Parameter	Symbol	Min.	Typ.	Max.	Unit
Power supply voltage	V _{cc}	4.5	5.0	5.5	V

●Block diagram

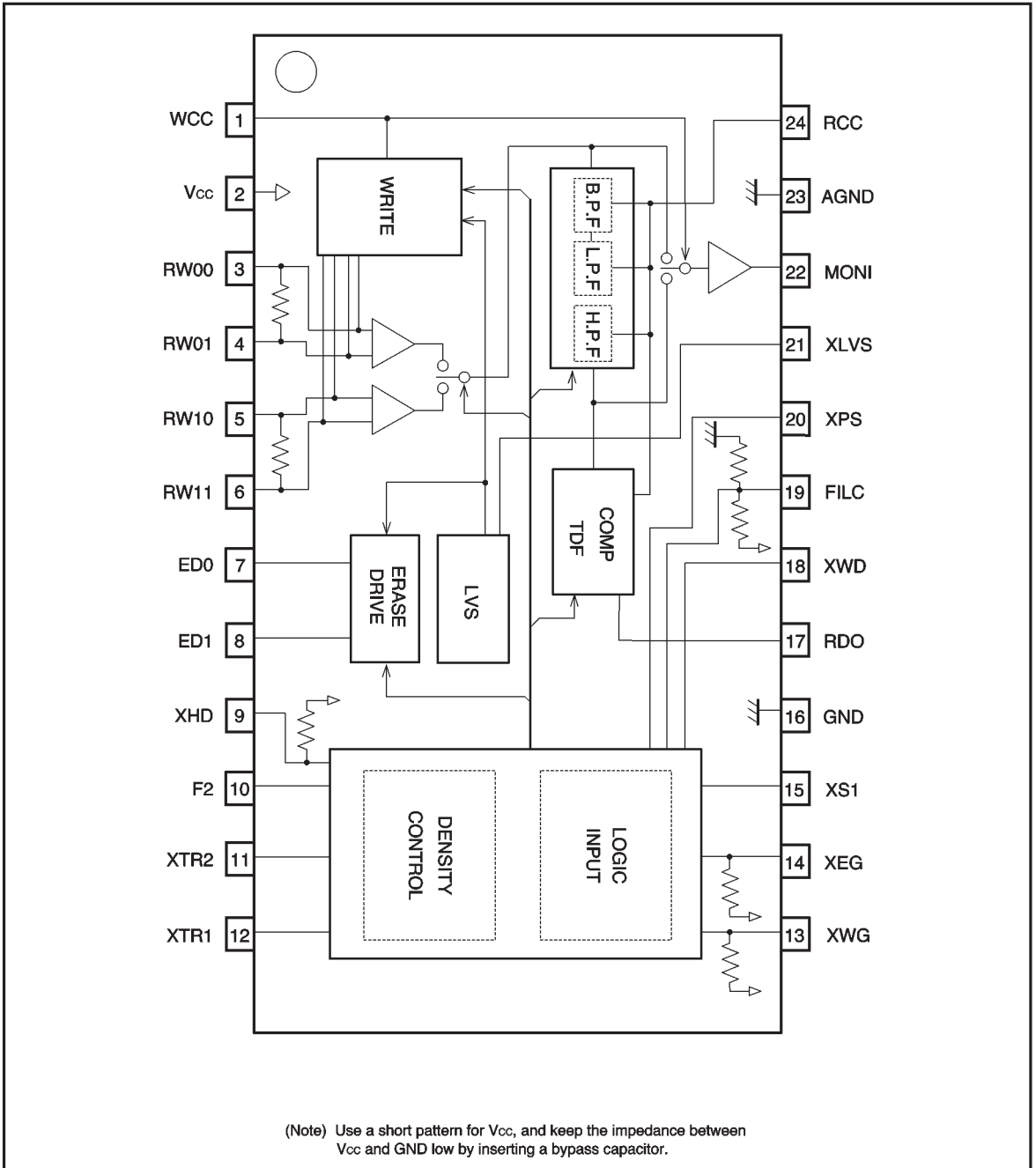

● Pin descriptions

Pin No.	Pin name	Equivalent circuit	Function
1	WCC		<p>For connecting the write current adjustment resistor</p> <p>Connect the write current adjustment resistor between this pin and Vcc</p> <p>Setting this pin to the low level during reading switches MONI to differentiator output</p>
2	Vcc		Power supply pin
3	RW00		<p>Active when SIDE0 and the read/write head connecting pin (pin 15, XS1) is at the high level (side 0)</p>
4	RW01		<p>Starts at RW00 during the start of writing (from reading to writing)</p>
5	RW10		<p>Active when the read / write head connecting pin (pin 15, XS1) is at the low level (side 1)</p>
6	RW11		<p>Starts at RW10 during the start of writing (from reading to writing)</p>
7	ED0		Side 0 erase current sink
8	ED1		Side 1 erase current sink

Pin No.	Pin name	Equivalent circuit	Function
9	XHD		1 MB/2 MB selector High = 1 MB Low = 2 MB
10	F2		1.6 MB drive selector Selector signal high level = active High = 1.6 MB drive, low = 2 MB drive
11	XTR2		Inner track / outer track position setting Controls the write current
12	XTR1 (XSWF)		Inner track/outer track position setting Controls the filter and write current
13	XWG		Write enable gate (Schmidt input) Low = active
14	XEG		Erase enable gate (Schmidt input) Low = active
15	XS1		Head / side switching signal Low = active (Schmidt input) High = side 0, low = side 1

Pin No.	Pin name	Equivalent circuit	Function
16	DGND	—————	Digital ground
17	RDO		Read data output TTL high level = active
18	XWD		Write data input Operates at falling edge (Schmidt input)
19	FILC		Filter control (f_0 , Q) Used to switch filter cutoff frequency (tri-state input)
20	XPS		Power save selector Low = active

Pin No.	Pin name	Equivalent circuit	Function
21	XLVS		<p>External low level - voltage detection pin Open collector output when low level voltage is detected Switches to low level when Vcc drops below the specified voltage</p>
22	MONI		<p>Preamplifier output and differentiator output monitoring Monitor is switched with pin 1 (WCC)</p>
23	AGND		<p>Analog ground</p>
24	RCC		<p>Filter (LPF, BPF) cutoff frequency and TDF 1st M/M pulse width setting resistor connection</p>

●Electrical characteristics (unless otherwise noted, Ta = 25°C, Vcc = 5V)

Supply current

Parameter	Symbol	Min.	Typ.	Max.	Unit	Conditions
Current dissipation,Standby	ICCST	—	165	400	μA	*1
Current dissipation,Read	ICCR	—	28	42	mA	*1
Current dissipation,Write	ICCW	—	8.5	15	mA	*2

*1 RRCC=2.0 [kΩ] (XHD=H)

*2 RWCC=2.4 [kΩ] (2 MB inner track, XTR2=H time, except IWR and IER)

Low level voltage detection circuit

Parameter	Symbol	Min.	Typ.	Max.	Unit	Conditions
Threshold voltage	VTH+	—	3.95	4.2	V	When power supply voltage rises
	VTH—	3.5	3.75	4.0	V	When power supply voltage falls
Hysteresis voltage	VH	50	—	—	mV	
Output low level voltage	VOL	—	—	0.40	V	Vcc=2.5[V] IOL=0.2[mA]
Output leakage current	IOH	—	—	10	μA	

Recovery time

Parameter	Symbol	Min.	Typ.	Max.	Unit	Conditions
POWER·SAVE→READ	TR2	—	—	500	μs	by XPS
READ→ERASE	TR3	—	—	6	μs	by XEG
READ→WRITE	TR4	—	—	4	μs	by XWG
WRITE→READ	TR5E	—	—	20	μs	by XEG
	TR5W	—	—	160	μs	by XWG
SIDE0↔SIDE1	TR6	—	—	40	μs	by XS1
1MB↔2MB	TR7	—	—	40	μs	by XHD
1.6 MB ↔2 MB	TR8	—	—	40	μs	by F2
Inner↔outer track	TR9	—	—	40	μs	by XTR1
Write current switch	TR10	—	—	40	μs	by XTR2

Preamplifier

Parameter	Symbol	Min.	Typ.	Max.	Unit	Conditions
Voltage gain (1)	GVD1	43	46	49	dB	f=125[kHz], VIN=2.5[mV _{P-P}] (XTR1=L) (differential)
Voltage gain (2)	GVD2	46	49	52	dB	f=125[kHz], VIN=2.5[mV _{P-P}] (XTR1=H) (differential)
SIDE0↔SIDE1 cross talk	GCTLK	50	—	—	dB	f=125[kHz], VIN=100[mV _{P-P}] (differential)*3
Differential input resistance	RID	—	8	—	kΩ	
Input conversion noise voltage	VN	—	2.5	3.7	μV _{rms}	f=500[Hz]~1[MHz]
Input sink current	ISINK	—	180	—	μA	
Differential input voltage amplitude (1)	VIN1	—	—	5.0	mV _{P-P}	Distortion factor 5% (with sine wave input) (XTR1=L)
Differential input voltage amplitude (2)	VIN2	—	—	3.5	mV _{P-P}	Distortion factor 5% (with sine wave input) (XTR1=H)
Common mode rejection ratio	CMRR	50	—	—	dB	f=125[kHz], VIN=100[mV _{P-P}] *3
Power supply rejection ratio	PSRR	40	—	—	dB	f=250[kHz], VIN=100[mV _{P-P}] *3

Preamplifier- L.P.F. - differentiator (B.P.F.)

Parameter	Symbol	Min.	Typ.	Max.	Unit	Conditions
Filter - time constant accuracy	EFIL	-10	—	+10	%	*3
Preamplifier - L.P.F. - Differentiator total gain (1)	GVDD1	40.5	44.5	48.5	dB	f=250[kHz], VIN=2.5[mV _{P-P}] (differential) (2MB setting XTR1 = L, FILC = H)
Preamplifier - L.P.F. - Differentiator total gain (2)	GVDD2	43.5	47.5	51.5	dB	f=250[kHz], VIN=2.5[mV _{P-P}] (differential) (2MB setting XTR1 = H, FILC = H)
Differentiator output peaking Frequency setting range	f _o	0.1	—	0.5	MHz	Defined by set-up Typ. value

*3 RRCC=2.0 [kΩ] (XHD=L, XTR1=H, F2=L, FILC=H)

Comparator and waveform shaping

Parameter	Symbol	Min.	Typ.	Max.	Unit	Conditions
TDF M/M pulse width accuracy(1)	TDF1	-10	—	+10	%	XHD=H, F2=L (Typ. : 2120[ns]) f=62.5[kHz]~125[kHz] *4
TDF M/M pulse width accuracy(2)	TDF2	-10	—	+10	%	XHD=H, F2=H (Typ. : 1800[ns]) f=62.5[kHz]~125[kHz] *4
TDF M/M pulse width accuracy(3)	TDF3	-10	—	+10	%	XHD=L, F2=H/L (Typ. : 1140[ns]) f=125 [kHz]~250 [kHz] *4
RD pulse width	TRD	270	400	530	ns	Judgment level 1.5[V]
Rise time	TTLH	—	—	70	ns	Rise time for 0.4 [V] - 2.0 [V]
Fall time	TTHL	—	—	70	ns	Fall time for 2.0 [V] - 0.4 [V]
Peak shift	P. S.	—	—	1.0	%	f=250[kHz], VIN=1[mV _{P-P}] (differential)
Output low level voltage	VOL	—	—	0.4	V	IOL=0.2[mA]
Output high level voltage	VOH	2.7	—	—	V	IOH=-15[μA] *5

*4 RRCC=2.0 [kΩ]

*5 Rise level from 0.4 [V] to 70 [ns]

Write circuit

Parameter	Symbol	Min.	Typ.	Max.	Unit	Conditions
Write current adjustment range	IWR	2.0	—	20	mA0-P	
Write current accuracy	ACIW	-7.0	—	+7.0	%	*6
Write current pairability	Δ IWR	-1.0	—	+1.0	%	RWCC=2.4 [k Ω]
Write current supply voltage dependency	PSIW	-4.0	-0.8	+3.0	% / V	RWCC=2.4 [k Ω]
Output saturation voltage	VSATRW	—	0.4	1.0	V	IWR=12[mA]
Off-state leakage current	ILKRW1	—	—	20	μ A	Unselected side
	ILKRW2	—	—	50	μ A	Selected side
Minimum write date pulse width	TWD	70	—	—	ns	
Write current inner / outer track ratio accuracy	ACIWTR	$\pm 10 \times (1 - \text{setting ratio})$			%	*7

*6 RWCC=1.2 [k Ω], each of XTR1, XTR2 can be set by the user.

*7 Setting ratio errors based on XTR1=L, XTR2=L

Erase output

Parameter	Symbol	Min.	Typ.	Max.	Unit	Conditions
Erase current setting range	IER	—	—	40	mA	
Output saturation voltage	VSATER	—	0.2	0.6	V	IER=40[mA]
Output leakage current	IOH	—	—	10	μ A	Off time, ED0=ED1=V _{CC}

Logic input

Parameter	Symbol	Min.	Typ.	Max.	Unit	Conditions
Input high level voltage	VIH	2.0	—	—	V	Except for FILC
Input low level voltage	VIL	—	—	0.8	V	Except for FILC
Input voltage hysteresis	VH	0.15	—	—	V	Applicable to XWD, XWG, XEG and XS1
Input low level current	IIL1	—	50	100	μ A	V _{CC} =5[V] VIL=GND Applicable to XWG, XEG, XHD, FILC
Input high level voltage 2	VIH2	4.2	—	—	V	Applicable to FILC
Input low level voltage 2	VIL2	—	—	0.8	V	Applicable to FILC

●Read characteristics

Density			1MB				1.6MB		2MB		
Transfer rate		FILC	250[kbps]		300[kbps]		500[kbps]		500[kbps]		
Input	Mode	XHD	NO CARE		HIGH		LOW		LOW		
		F2	NO CARE		LOW		HIGH		LOW		
	Track	XTR1 (XSWF)	NO CARE		Outer track LOW	Inner track HIGH	Outer track LOW	Inner track HIGH	Outer track LOW	Inner track HIGH	
	Filter	fo [kHz] (Characteristics) *1	HIGH	150	158	178	185	323	404	366	358(C)
			LOW	↑	↑	↑	↑	300	366	338	361(B)
TDF	[nSEC]	NO CARE	2120		1800		1140		1140		

*1 (B) Chebyshev's characteristics

(However, RRCC=2.0 [kΩ])

(C) Except for the high ripple Chebyshev's characteristics, 2MB inner track, all are Butterworth characteristics. Refer to filter characteristics.

Total filter peak frequency setting

$$f_0 = a / (RRCC [k\Omega] + 0.09) [kHz]$$

FILC	"H"	"L"	
a =	313	313	250 [kbps] outer track
	330	330	250 [kbps] inner track
	376	376	300 [kbps] outer track
	387	387	300 [kbps] inner track
	675	627	500 [kbps] outer track (when F2 = H)
	844	765	500 [kbps] inner track (when F2 = H)
	765	706	500 [kbps] outer track (when F2 = L)
	748	754	500 [kbps] inner track (when F2 = L)

TDF time constant setting

250 [kbps] : T = 758 × RRCC [kΩ] + 604 [ns]

500 [kbps] : T = 683 × RRCC [kΩ] + 434 [ns]

500 [kbps] : T = 333 × RRCC [kΩ] + 388 [ns]

●Write current switching ratio

Track		Outer track ←—————→ Inner track			
Density	XTR1	L		H	
	XTR2	L	H	L	H
2MB		0.383	0.350	0.333	0.300
1.6MB		0.450	0.417	0.383	0.350
1MB (250kbps)		0.933	0.900	0.800	0.733
1MB (300kbps)		0.933	0.900	0.800	0.733

Write current setting

$$I_{wr} = \frac{24.0}{RWCC [k\Omega]} [mA]$$

● Filter characteristic

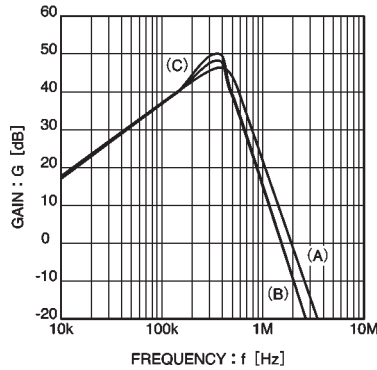
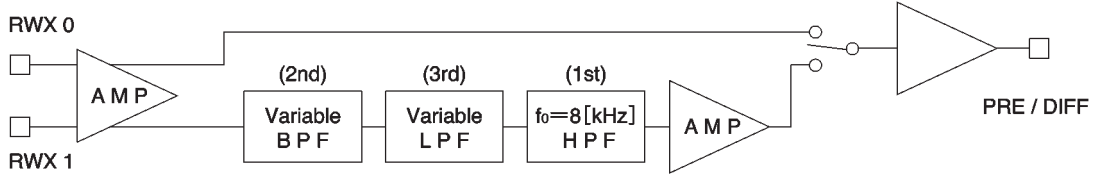
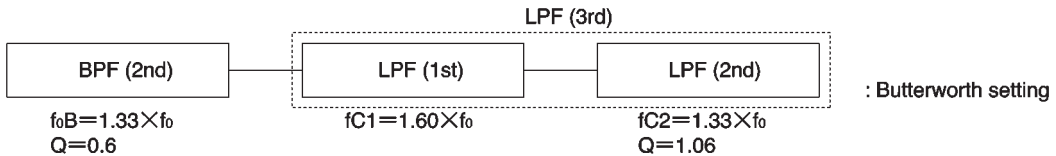

Fig. 1 PRE IN vs. DIFF OUT characteristics

Preamplifier - differentiator (B.P.F.) - L.P.F.



(A) [1M/1.6M/2M outer track] total characteristics peak frequency f_0



(B) FILC = "L" time [2M inner track] total characteristics peak frequency f_0

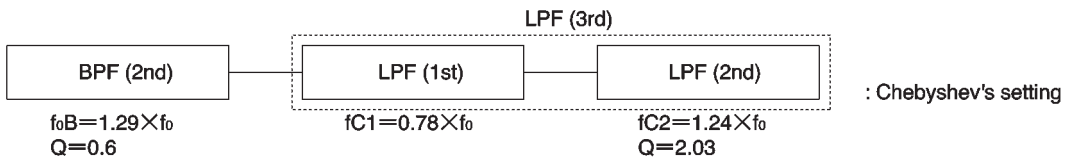

(C) FILC = "H" time [2M inner track] total characteristics peak frequency f_0

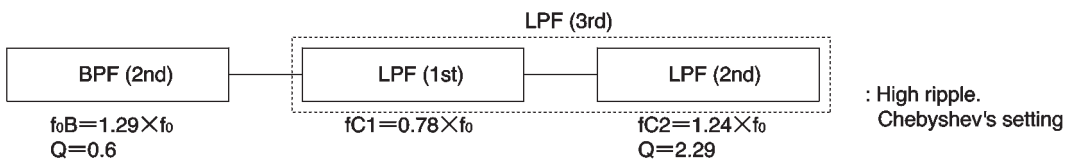

● Measurement circuit

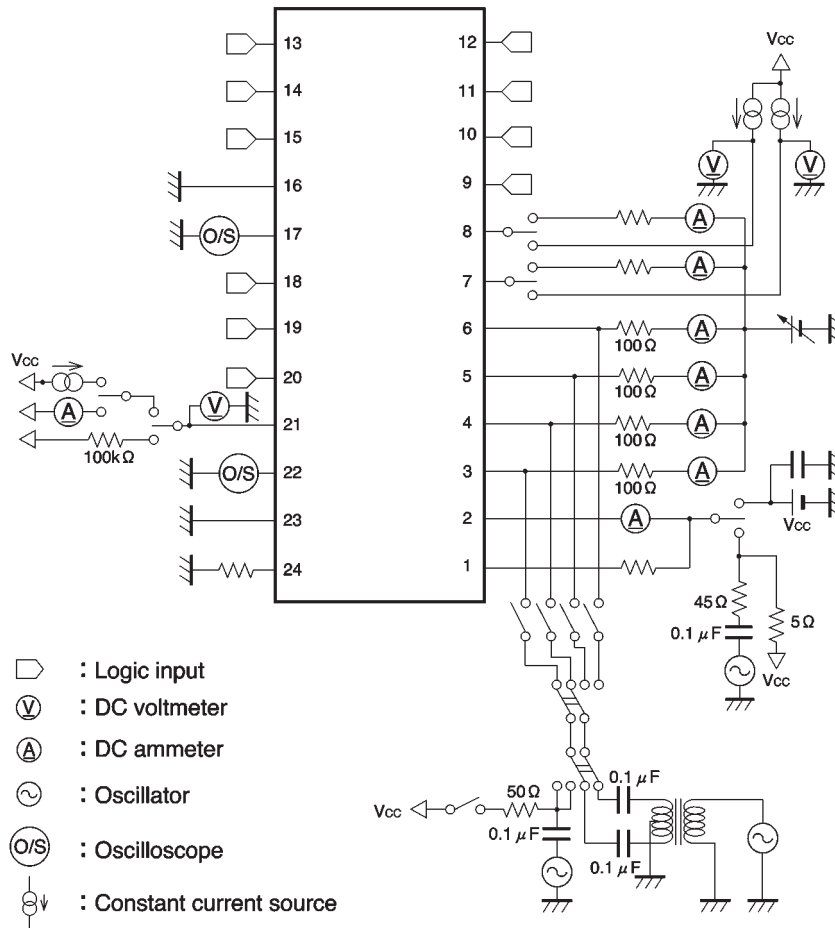

Fig. 2

● Circuit operation

(1) Read

The input signal from the head coils from each side of the disc is amplified by the preamplifier and then differentiated. The filter time constant can be set externally. After differentiation, the differential output is input to the comparator. The time domain filter detects zero cross, and the output is converted to read data. The monostable multivibrator width can be set externally, while the read data pulse width is a constant 400ns.

(2) Write

Input write data are converted to toggle movements by

the internal flip-flops, operating the write driver. The write driver current is supplied by the write current generator, but the externally set current can be controlled according to density and by selecting inner track/outer track.

(3) Erase

An open collector output pin is used, and the erase current is set with a resistor between it and the head.

(4) Power supply

When the low level voltage detector detects a drop in the supply voltage, writing and erasing are prohibited.

● Operation notes

- (1) Use a short pattern for V_{CC} , and a sufficiently wide AGND and DGND. Keep the impedance between V_{CC} and GND low by inserting a bypass capacitor.
- (2) Use a pattern that will minimize interference between digital signals and the head.

● Electrical characteristic curves

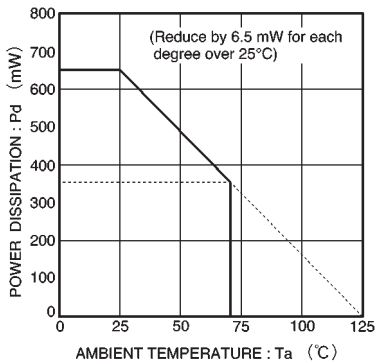

Fig. 3 Thermal derating characteristics

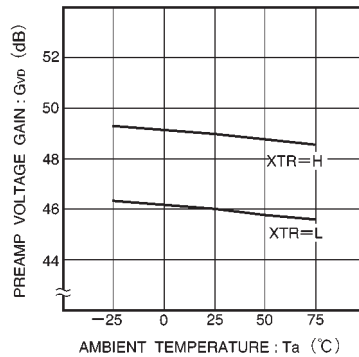

Fig. 4 Preamp voltage gain vs. ambient temperature

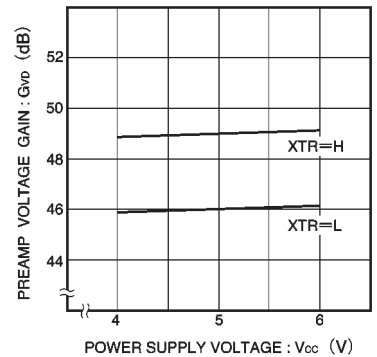

Fig. 5 Preamp voltage gain vs. power supply voltage

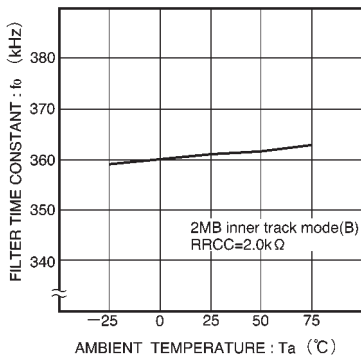

Fig. 6 Filter time constant (f_0) vs. ambient temperature

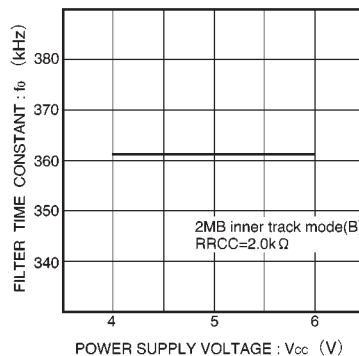

Fig. 7 Filter time constant (f_0) vs. power supply voltage

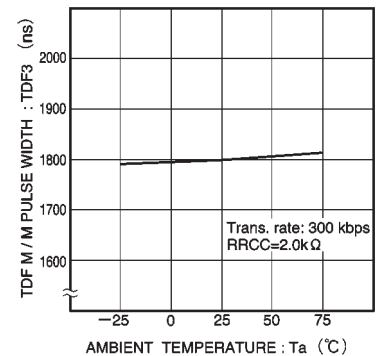

Fig. 8 TDF time constant vs. ambient temperature

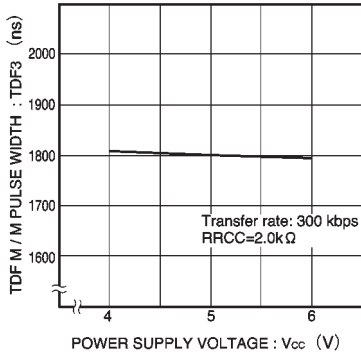

Fig. 9 TDF time constant vs. power supply voltage

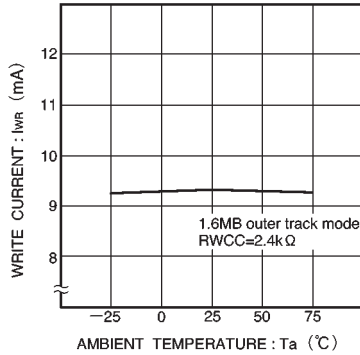

Fig. 10 Write current vs. ambient temperature

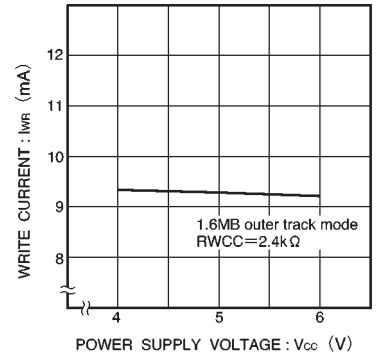

Fig. 11 Write current vs. power supply voltage

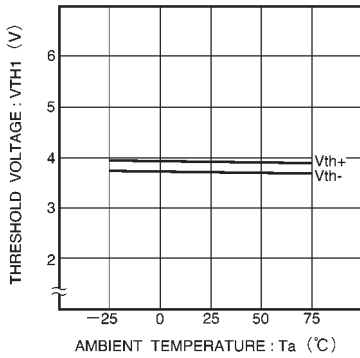

Fig. 12 Low level detection voltage vs. ambient temperature

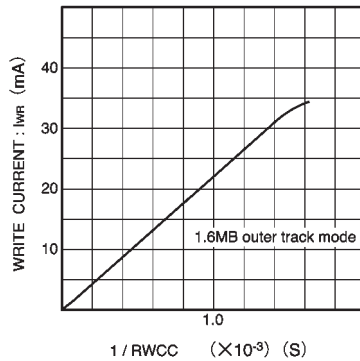

Fig. 13 Write current vs. write current adjustment resistance

● External dimensions (Units: mm)

